

Contents

1. SAFETY PRECAUTIONS.....	1
1.1. Precautions for using R32 refrigerant.....	2
2. PRODUCT SPECIFICATION.....	3
2.1. Installation tools.....	3
2.2. Accessories.....	4
2.3. Pipe requirement.....	4
2.4. Electrical requirement.....	4
2.5. Optional parts.....	4
3. INSTALLATION WORK.....	4
3.1. Selecting an installation location.....	5
3.2. Removing and replacing parts.....	5
3.3. Pipe installation.....	6
3.4. Electrical wiring.....	8
3.5. Remote controller installation.....	9
4. OPTIONAL INSTALLATION WORK.....	9
4.1. Optional kit installation.....	9
4.2. Group control.....	11
5. FUNCTION SETTING.....	11
5.1. Function details.....	11
6. TEST RUN.....	13
7. FINISHING.....	13
8. CUSTOMER GUIDANCE.....	13
9. ERROR CODES.....	13

1. SAFETY PRECAUTIONS

- Be sure to read this manual thoroughly before installation.
- The warnings and precautions indicated in this manual contain important information pertaining to your safety. Be sure to observe them.
- Hand this manual, together with the operation manual, to the customer. Request the customer to keep them on hand for future use, such as for relocating or repairing the unit.

WARNING

Indicates a potentially or imminently hazardous situation which, if not avoided, could result in death or serious injury.

CAUTION

Indicates a potentially hazardous situation that may result in minor or moderate injury or damage to property.

WARNING

- The appliance shall be installed, operated and stored in a room with a floor area larger than X m².

Amount of refrigerant charge M (kg)	Minimum room area X (m ²)
M ≤ 1.22	-
1.22 < M ≤ 1.23	1.45
1.23 < M ≤ 1.50	2.15
1.50 < M ≤ 1.75	2.92
1.75 < M ≤ 2.0	3.82
2.0 < M ≤ 2.5	5.96
2.5 < M ≤ 3.0	8.59
3.0 < M ≤ 3.5	11.68
3.5 < M ≤ 4.0	15.26

(IEC 60335-2-40)

- Installation of this product must be done by experienced service technicians or professional installers only in accordance with this manual. Installation by non-professional or improper installation of the product might cause serious accidents such as injury, water leakage, electric shock, or fire. If the product is installed in disregard of the instructions in this manual, it will void the manufacturer's warranty.
- Do not turn on the power until all work has been completed. Turning on the power before the work is completed can cause serious accidents such as electric shock or fire.
- If refrigerant leaks when you are working, ventilate the area. If the leaking refrigerant is exposed to a direct flame, it may produce a toxic gas.
- Installation must be performed in accordance with regulations, codes, or standards for electrical wiring and equipment in each country, region, or the installation place.
- Do not use means to accelerate the defrosting process or to clean, other than those recommended by the manufacturer.
- This appliance is not intended for use by persons (including children) with reduced physical, sensory or mental capabilities, or lack of experience and knowledge, unless they have been given supervision or instruction concerning use of the appliance by a person responsible for their safety. Children should be supervised to ensure that they do not play with the appliance.
- To avoid danger of suffocation, keep the plastic bag or thin film used as the packaging material away from young children.
- The appliance shall be stored in a room without continuously operating ignition sources (for example: open flames, an operating gas appliance or an operating electric heater).
- Do not pierce or burn.
- Be aware that refrigerants may not contain an odour.

CAUTION

- Read carefully all safety information written in this manual before you install or use the air conditioner.
- Install the product by following local codes and regulations in force at the place of installation, and the instructions provided by the manufacturer.
- This product is part of a set constituting an air conditioner. The product must not be installed alone or be installed with a device not authorized by the manufacturer.
- Always use a separate power supply line protected by a circuit breaker operating on all wires with a distance between contact of 3 mm for this product.
- To protect the persons, ground (earth) the product correctly, and use the power cable combined with an Earth Leakage Circuit Breaker (ELCB).
- This product is not explosion proof, and therefore should not be installed in an explosive atmosphere.
- To avoid getting an electric shock, never touch the electrical components soon after the power supply has been turned off. After turning off the power, always wait 5 minutes or more before you touch the electrical components.
- This product contains no user-serviceable parts. Always consult experienced service technicians for repairing.
- When moving or relocating the air conditioner, consult experienced service technicians for disconnection and reinstallation of the product.
- Do not touch the aluminum fins of heat exchanger built-in the indoor or outdoor unit to avoid personal injury when you install or maintain the unit.
- Do not place any other electrical products or household belongings under the product. Condensation dripping from the product might get them wet, and may cause damage or malfunction to the property.

- Be careful not to scratch the air conditioner when handling it.

1.1. Precautions for using R32 refrigerant

The basic installation work procedures are the same as conventional refrigerant (R410A, R22) models.

However, pay careful attention to the following points:

Since the working pressure is 1.6 times higher than that of refrigerant R22 models, some of the piping and installation and service tools are special. (Refer to "2.1. Installation tools".)

Especially, when replacing a refrigerant R22 model with a new refrigerant R32 model, always replace the conventional piping and flare nuts with the R32 and R410A piping and flare nuts on the outdoor unit side.

For R32 and R410A, the same flare nut on the outdoor unit side and pipe can be used.

Models that use refrigerant R32 and R410A have a different charging port thread diameter to prevent erroneous charging with refrigerant R22 and for safety. Therefore, check beforehand. [The charging port thread diameter for R32 and R410A is 1/2-20 UNF.]

Be more careful than R22 so that foreign matter (oil, water, etc.) does not enter the piping. Also, when storing the piping, securely seal the opening by pinching, taping, etc. (Handling of R32 is similar to R410A.)

CAUTION

1-Installation (Space)

- That the installation of pipe-work shall be kept to a minimum.
- That pipe-work shall be protected from physical damage.
- The appliance shall not be installed in an unventilated space, if that space is smaller than X m².

Amount of refrigerant charge M (kg)	Minimum room area X (m ²)
M ≤ 1.22	-
1.22 < M ≤ 1.23	1.45
1.23 < M ≤ 1.50	2.15
1.50 < M ≤ 1.75	2.92
1.75 < M ≤ 2.0	3.82
2.0 < M ≤ 2.5	5.96
2.5 < M ≤ 3.0	8.59
3.0 < M ≤ 3.5	11.68
3.5 < M ≤ 4.0	15.26

(IEC 60335-2-40)

- That compliance with national gas regulations shall be observed.
- That mechanical connections shall be accessible for maintenance purposes.
- In cases that require mechanical ventilation, ventilation openings shall be kept clear of obstruction.
- When disposing of the product is used, be based on national regulations, properly processed.

2-Serviceing

2-1 Service personnel

- Any person who is involved with working on or breaking into a refrigerant circuit should hold a current valid certificate from an industry-accredited assessment authority, which authorises their competence to handle refrigerants safely in accordance with an industry recognised assessment specification.
- Servicing shall only be performed as recommended by the equipment manufacturer. Maintenance and repair requiring the assistance of other skilled personnel shall be carried out under the supervision of the person competent in the use of flammable refrigerants.
- Servicing shall be performed only as recommended by the manufacturer.

2-2 Work

- Prior to beginning work on systems containing flammable refrigerants, safety checks are necessary to ensure that the risk of ignition is minimized. For repair to the refrigerating system, the precautions in 2-2 to 2-8 shall be complied with prior to conducting work on the system.
- Work shall be undertaken under a controlled procedure so as to minimize the risk of a flammable gas or vapour being present while the work is being performed.
- All maintenance staff and others working in the local area shall be instructed on the nature of work being carried out.
- Work in confined spaces shall be avoided.
- The area around the workspace shall be sectioned off.
- Ensure that the conditions within the area have been made safe by control of flammable material.

2-3 Checking for presence of refrigerant

- The area shall be checked with an appropriate refrigerant detector prior to and during work, to ensure the technician is aware of potentially flammable atmospheres.
- Ensure that the leak detection equipment being used is suitable for use with flammable refrigerants, i.e. nonsparking, adequately sealed or intrinsically safe.

2-4 Presence of fire extinguisher

- If any hot work is to be conducted on the refrigeration equipment or any associated parts, appropriate fire extinguishing equipment shall be available at hand.
- Have a dry powder or CO₂ fire extinguisher adjacent to the charging area.

CAUTION

2-5 No ignition sources

- No person carrying out work in relation to a refrigeration system which involves exposing any pipe work that contains or has contained flammable refrigerant shall use any sources of ignition in such a manner that it may lead to the risk of fire or explosion.
- All possible ignition sources, including cigarette smoking, should be kept sufficiently far away from the site of installation, repairing, removing and disposal, during which flammable refrigerant can possibly be released to the surrounding space.
- Prior to work taking place, the area around the equipment is to be surveyed to make sure that there are no flammable hazards or ignition risks. "No Smoking" signs shall be displayed.

2-6 Ventilated area

- Ensure that the area is in the open or that it is adequately ventilated before breaking into the system or conducting any hot work.
- A degree of ventilation shall continue during the period that the work is carried out.
- The ventilation should safely disperse any released refrigerant and preferably expel it externally into the atmosphere.

2-7 Checks to the refrigeration equipment

- Where electrical components are being changed, they shall be fit for the purpose and to the correct specification.
- At all times the manufacturer's maintenance and service guidelines shall be followed.
- If in doubt consult the manufacturer's technical department for assistance.
- The following checks shall be applied to installations using flammable refrigerants.
 - The charge size is in accordance with the room size within which the refrigerant containing parts are installed.
 - The ventilation machinery and outlets are operating adequately and are not obstructed.
 - If an indirect refrigerating circuit is being used, the secondary circuit shall be checked for the presence of refrigerant.
 - Marking to the equipment continues to be visible and legible. Markings and signs that are illegible shall be corrected.
 - Refrigeration pipe or components are installed in a position where they are unlikely to be exposed to any substance which may corrode refrigerant containing components, unless the components are constructed of materials which are inherently resistant to being corroded or are suitably protected against being so corroded.

2-8 Checks to electrical devices

- Repair and maintenance to electrical components shall include initial safety checks and component inspection procedures.
- If a fault exists that could compromise safety, then no electrical supply shall be connected to the circuit until it is satisfactorily dealt with.
- If the fault cannot be corrected immediately but it is necessary to continue operation, an adequate temporary solution shall be used.
- This shall be reported to the owner of the equipment so all parties are advised.
- Initial safety checks shall include.
 - That capacitors are discharged: this shall be done in a safe manner to avoid possibility of sparking.
 - That there no live electrical components and wiring are exposed while charging, recovering or purging the system.
 - That there is continuity of earth bonding.

3-Repairs to sealed components

- During repairs to sealed components, all electrical supplies shall be disconnected from the equipment being worked upon prior to any removal of sealed covers, etc.
- If it is absolutely necessary to have an electrical supply to equipment during servicing, then a permanently operating form of leak detection shall be located at the most critical point to warn of a potentially hazardous situation.
- Particular attention shall be paid to the following to ensure that by working on electrical components, the casing is not altered in such a way that the level of protection is affected.
 - This shall include damage to cables, excessive number of connections, terminals not made to original specification, damage to seals, incorrect fitting of glands, etc.
 - Ensure that apparatus is mounted securely.
 - Ensure that seals or sealing materials have not degraded such that they no longer serve the purpose of preventing the ingress of flammable atmospheres.
 - Replacement parts shall be in accordance with the manufacturer's specifications.

NOTES: The use of silicon sealant may inhibit the effectiveness of some types of leak detection equipment.
Intrinsically safe components do not have to be isolated prior to working on them.

4-Repair to intrinsically safe components

- Do not apply any permanent inductive or capacitance loads to the circuit without ensuring that this will not exceed the permissible voltage and current permitted for the equipment in use.
- Intrinsically safe components are the only types that can be worked on while live in the presence of a flammable atmosphere.
- The test apparatus shall be at the correct rating.
- Replace components only with parts specified by the manufacturer.
- Other parts may result in the ignition of refrigerant in the atmosphere from a leak.

5-Cabling

- Check that cabling will not be subject to wear, corrosion, excessive pressure, vibration, sharp edges or any other adverse environmental effects.
- The check shall also take into account the effects of aging or continual vibration from sources such as compressors or fans.

6-Detection of flammable refrigerants

- Under no circumstances shall potential sources of ignition be used in the searching for or detection of refrigerant leaks.
- A halide torch (or any other detector using a naked flame) shall not be used.

 **CAUTION**

7-Leak detection methods

- Electronic leak detectors shall be used to detect flammable refrigerants, but the sensitivity may not be adequate, or may need re-calibration. (Detection equipment shall be calibrated in a refrigerant-free area.)
- Ensure that the detector is not a potential source of ignition and is suitable for the refrigerant used.
- Leak detection equipment shall be set at a percentage of the LFL of the refrigerant and shall be calibrated to the refrigerant employed and the appropriate percentage of gas (25 % maximum) is confirmed.
- Leak detection fluids are suitable for use with most refrigerants but the use of detergents containing chlorine shall be avoided as the chlorine may react with the refrigerant and corrode the copper pipe-work.
- If a leak is suspected, all naked flames shall be removed/extinguished.
- If a leakage of refrigerant is found which requires brazing, all of the refrigerant shall be recovered from the system, or isolated (by means of shut off valves) in a part of the system remote from the leak. Oxygen free nitrogen (OFN) shall then be purged through the system both before and during the brazing process.

8-Removal and evacuation

- When breaking into the refrigerant circuit to make repairs – or for any other purpose –conventional procedures shall be used. However, it is important that best practice is followed since flammability is a consideration. The following procedure shall be adhered to:
 - remove refrigerant
 - purge the circuit with inert gas
 - evacuate
 - purge again with inert gas
 - open the circuit by cutting or brazing
- The refrigerant charge shall be recovered into the correct recovery cylinders.
- The system shall be "flushed" with OFN to render the unit safe.
- This process may need to be repeated several times.
- Compressed air or oxygen shall not be used for this task.
- Flushing shall be achieved by breaking the vacuum in the system with OFN and continuing to fill until the working pressure is achieved, then venting to atmosphere, and finally pulling down to a vacuum.
- This process shall be repeated until no refrigerant is within the system.
- When the final OFN charge is used, the system shall be vented down to atmospheric pressure to enable work to take place.
- This operation is absolutely vital if brazing operations on the pipe work are to take place.
- Ensure that the outlet for the vacuum pump is not close to any ignition sources and there is ventilation available.

9-Charging procedures

- In addition to conventional charging procedures, the following requirements shall be followed.
 - Ensure that contamination of different refrigerants does not occur when using charging equipment. Hoses or lines shall be as short as possible to minimize the amount of refrigerant contained in them.
 - Cylinders shall be kept upright.
 - Ensure that the refrigeration system is earthed prior to charging the system with refrigerant.
 - Label the system when charging is complete (if not already).
 - Extreme care shall be taken not to overfill the refrigeration system.
- Prior to recharging the system it shall be pressure tested with OFN.
- The system shall be leak tested on completion of charging but prior to commissioning.
- A follow up leak test shall be carried out prior to leaving the site.

10-Decommissioning

- Before carrying out this procedure, it is essential that the technician is completely familiar with the equipment and all its details.
- It is recommended good practice that all refrigerants are recovered safely.
- Prior to the task being carried out, an oil and refrigerant sample shall be taken in case analysis is required prior to re-use of reclaimed refrigerant.
- It is essential that electrical power is available before the task is commenced.
 - a) Become familiar with the equipment and its operation.
 - b) Isolate system electrically.
 - c) Before attempting the procedure ensure that:
 - mechanical handling equipment is available, if required, for handling refrigerant cylinders;
 - all personal protective equipment is available and being used correctly;
 - the recovery process is supervised at all times by a competent person;
 - recovery equipment and cylinders conform to the appropriate standards.
 - d) Pump down refrigerant system, if possible.
 - e) If a vacuum is not possible, make a manifold so that refrigerant can be removed from various parts of the system.
 - f) Make sure that cylinder is situated on the scales before recovery takes place.
 - g) Start the recovery machine and operate in accordance with manufacturer's instructions.
 - h) Do not overfill cylinders. (No more than 80 % volume liquid charge).
 - i) Do not exceed the maximum working pressure of the cylinder, even temporarily.
 - j) When the cylinders have been filled correctly and the process completed, make sure that the cylinders and the equipment are removed from site promptly and all isolation valves on the equipment are closed off.
 - k) Recovered refrigerant shall not be charged into another refrigeration system unless it has been cleaned and checked.

 **CAUTION**





11-Labeling

- Equipment shall be labelled stating that it has been de-commissioned and emptied of refrigerant.
- The label shall be dated and signed.
- Ensure that there are labels on the equipment stating the equipment contains flammable refrigerant.

12-Recovery

- When removing refrigerant from a system, either for servicing or decommissioning, it is recommended good practice that all refrigerants are removed safely.
- When transferring refrigerant into cylinders, ensure that only appropriate refrigerant recovery cylinders are employed.
- Ensure that the correct number of cylinders for holding the total system charge are available.
- All cylinders to be used are designated for the recovered refrigerant and labelled for that refrigerant (i.e. special cylinders for the recovery of refrigerant).
- Cylinders shall be complete with pressure relief valve and associated shut-off valves in good working order.
- Empty recovery cylinders are evacuated and, if possible, cooled before recovery occurs.
- The recovery equipment shall be in good working order with a set of instructions concerning the equipment that is at hand and shall be suitable for the recovery of flammable refrigerants.
- In addition, a set of calibrated weighing scales shall be available and in good working order.
- Hoses shall be complete with leak-free disconnect couplings and in good condition.
- Before using the recovery machine, check that it is in satisfactory working order, has been properly maintained and that any associated electrical components are sealed to prevent ignition in the event of a refrigerant release. Consult manufacturer if in doubt.
- The recovered refrigerant shall be returned to the refrigerant supplier in the correct recovery cylinder, and the relevant Waste Transfer Note arranged.
- Do not mix refrigerants in recovery units and especially not in cylinders.
- If compressors or compressor oils are to be removed, ensure that they have been evacuated to an acceptable level to make certain that flammable refrigerant does not remain within the lubricant.
- The evacuation process shall be carried out prior to returning the compressor to the suppliers.
- Only electric heating to the compressor body shall be employed to accelerate this process.
- When oil is drained from a system, it shall be carried out safely.

Explanation of symbols displayed on the indoor unit or outdoor unit.

	WARNING	This symbol shows that this appliance uses a flammable refrigerant. If the refrigerant is leaked and exposed to an external ignition source, there is a risk of fire.
	CAUTION	This symbol shows that the operation manual should be read carefully.
	CAUTION	This symbol shows that a service personnel should be handling this equipment with reference to the installation manual.
	CAUTION	This symbol shows that information is available such as the operation manual or installation manual.

2. PRODUCT SPECIFICATION

2.1. Installation tools

Tool name	Contents of change
Gauge manifold	Pressure is high and cannot be measured with a R22 gauge. To prevent erroneous mixing of other refrigerants, the diameter of each port has been changed. It is recommended to use gauge with seals -0.1 to 5.3 MPa (-1 to 53 bar) for high pressure. -0.1 to 3.8 MPa (-1 to 38 bar) for low pressure.
Charge hose	To increase pressure resistance, the hose material and base size were changed. (R32/R410A)
Vacuum pump	A conventional vacuum pump can be used by installing a vacuum pump adapter. (Use of a vacuum pump with a series motor is prohibited.)
Gas leakage detector	Special gas leakage detector for HFC refrigerant R410A or R32.

■ Copper pipes

It is necessary to use seamless copper pipes and it is desirable that the amount of residual oil is less than 40 mg/10 m. Do not use copper pipes having a collapsed, deformed or discolored portion (especially on the interior surface). Otherwise, the expansion valve or capillary tube may become blocked with contaminants. As an air conditioner using R32 (R410A) incurs pressure higher than when using R22, it is necessary to choose adequate materials.

⚠ WARNING











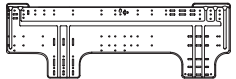

- Do not use the existing (for R22) piping and flare nuts. If the existing materials are used, the pressure inside the refrigerant cycle will rise and cause failure, injury, etc. (Use the special R32/R410A materials.)
- Use (refill or replace with) specified refrigerant (R32) only. Use of unspecified refrigerant can cause product malfunction, burst, or injury.
- Do not mix any gas or impurities except specified refrigerant (R32). Inflow of air or application of unspecified material makes the internal pressure of the refrigerant cycle too high, and may cause product malfunction, burst of piping, or injury.
- For installation purposes, be sure to use the parts supplied by the manufacturer or other prescribed parts. The use of non-prescribed parts can cause serious accidents such as the unit falling, water leakage, electric shock, or fire.
- Do not turn on the power until all work has been completed.

⚠ CAUTION

This manual describes how to install the indoor unit only. To install the outdoor unit or branch box, (if any), refer to the installation manual included in each product.

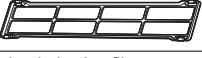
2.2. Accessories

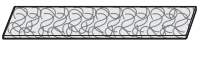
The following installation accessories are supplied. Use them as required.

Name and Shape	Q'ty	Name and Shape	Q'ty
Operation manual 	1	Wall hook bracket 	1
Operation manual (CD-ROM) 	1	Self-tapping screws (large) 	8
Installation manual (This manual) 	1	Drain hose insulation 	1
Remote controller 	1	Cloth tape 	1
Battery 	2	Air cleaning filter holder 	2
Remote controller holder 	1	Ion deodorization filter (light blue) 	1
Self-tapping screws (small) 	2	Apple-catechin filter (White) 	1

The following items are necessary to install this air conditioner. (The items are not included with the air conditioner and must be purchased separately.)

Additional materials	
Connection pipe assembly	Wall cap
Connection cable (4-conductor)	Saddle
Wall pipe	Drain hose
Decorative tape	Self-tapping screws
Vinyl tape	Sealant
Putty	

2.3. Pipe requirement

⚠ CAUTION

Refer to the installation manual for the outdoor unit for description of allowable pipe length and height difference.

Gas pipe size [mm(in)] <thickness [mm]>	Liquid pipe size [mm(in)] <thickness [mm]>
∅ 15.88 (∅ 5/8) <0.80>	∅ 9.52 (∅ 3/8) <0.80>

⚠ CAUTION

- Wrap heat insulation around both gas pipe and liquid pipe. No heat-insulation work or incorrect heat-insulation work may cause water leaks.
- In a reverse cycle model, use heat insulation with heat resistance above 120 °C.
- If expected humidity of the installation location of refrigerant pipes is higher than 70 %, wrap the heat insulation around the refrigerant pipes. If the expected humidity is between 70 % and 80 %, use heat insulation that has a thickness of 15 mm or more. If the expected humidity is higher than 80 %, use heat insulation that has a thickness of 20 mm or more.
- The use of thinner heat insulation than specified above, may cause a condensation on the surface of the insulation.
- Use heat insulation with thermal conductivity of 0.045 W/(m·K) or less, at 20 °C.

2.4. Electrical requirement

The indoor unit is powered from the outdoor unit. Do not power indoor unit from separate power source.

⚠ WARNING

Standard for electrical wiring and equipment differs in each country or region. Before you start electrical working, confirm related regulations, codes, or standards.

Cable	Conductor size [mm ²]	Type	Remarks
Connection cable	1.5 - 2.5	Type 60245 IEC 57	3 cable + Ground (Earth), 1 ∅ 230 V

Cable Length: Limit voltage drop to less than 2 %. Increase cable gauge if voltage drop is 2 % or more.

2.5. Optional parts

Refer to each installation manual for the method of installing optional parts.

Parts name	Model No.	Application
Wired remote controller (*1)	UTY-RNR*Z*	For air conditioner operation (2-wired type)
	UTY-RLR*	
Compact wired remote controller (*1)	UTY-RCR*Z*	
Simple remote controller (*1)	UTY-RSR*	
	UTY-RHR*	
Communication kit	UTY-TWRXZ2	For the installation of wired/simple remote controller
External input and output PCB (*2)	UTY-XCSXZ2	For control input/output port
External connect kit	UTY-XWZX UTY-XWZXZ5	
WLAN adapter	UTY-TFSXF2	For wireless LAN control
Modbus converter	UTY-VMSX	Only one communication converter can be connected.
KNX convertor	UTY-VKXSX	

* Optional parts are subject to change without notice.

*1: Optional Communication kit (UTY-TWRXZ2) is necessary for installation.

*2: Optional External connect kit (UTY-XWZXZ5) is necessary for installation.

3. INSTALLATION WORK

⚠ WARNING

During transportation or relocation of the indoor unit, pipes shall be covered with the wall hook bracket for protection. Do not move the appliance by holding the indoor unit pipes. (The stress applied to the pipe joints may cause the flammable gas to leak during operation.)

⚠ CAUTION

- Do not hit or push the occupancy sensor. This may lead to damage or malfunction.
- Do not touch the occupancy sensor. Any scratches or dirt may lead to incorrect detection.
- Do not place large objects near the occupancy sensor. Also keep heating units outside the sensor's detection area.

Detection range of the occupancy sensor is as follows.

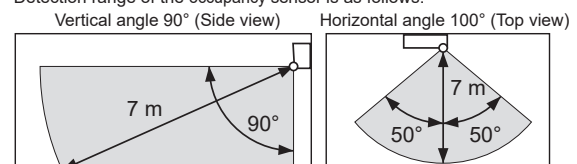

3.1. Selecting an installation location

Decide the mounting position with the customer as follows:

- (1) Install the indoor unit level on a strong wall which is not subject to vibration.
- (2) The inlet and outlet ports should not be obstructed: the air should be able to blow all over the room.
- (3) Install the unit on a dedicated electrical branch circuit.
- (4) Do not install the unit where it will be exposed to direct sunlight.
- (5) Install the unit where connection to the outdoor unit is easy.
- (6) Install the unit where the drain pipe can be easily installed.
- (7) Take servicing, etc. into consideration and leave the spaces. Also install the unit where the filter can be removed.

Correct initial installation location is important because it is difficult to move the unit after it is installed.

⚠ WARNING

Install the indoor unit where is capable to support the weight of the unit. Secure the unit firmly so that the unit does not topple or fall.

⚠ CAUTION

- Do not install the unit in the following areas:
 - Area with high salt content, such as at the seaside. It will deteriorate metal parts, causing the parts to fail or the unit to leak water.
 - Area filled with mineral oil or containing a large amount of splashed oil or steam, such as a kitchen. It will deteriorate plastic parts, causing the parts to fail or the unit to leak water.
 - Area where is close to heat sources.
 - Area that generates substances that adversely affect the equipment, such as sulfuric gas, chlorine gas, acid, or alkali. It will cause the copper pipes and brazed joints to corrode, which can cause refrigerant leakage.
 - Area that can cause combustible gas to leak, contains suspended carbon fibers or flammable dust, or volatile in flammables such as paint thinner or gasoline.
 - If gas leaks and settles around the unit, it can cause a fire.
 - Area where animals may urinate on the unit or ammonia may be generated.
- Do not use the unit for special purposes, such as storing food, raising animals, growing plants, or preserving precision devices or art objects. It can degrade the quality of the preserved or stored objects.
- Install the unit where drainage does not cause any trouble.
- Install the indoor unit, outdoor unit, power supply cable, connection cable, and remote control cable at least 1 m away from a television or radio receivers. The purpose of this is to prevent TV reception interference or radio noise. (Even if they are installed more than 1 m apart, you could still receive noise under some signal conditions.)
- If children under 10 years old may approach the unit, take preventive measures so that they cannot reach the unit.
- Install the indoor unit on the wall where the height from the floor is more than 1.8 m.

3.1.1. Installation dimensions

Keep the distance between the wall hook bracket or indoor unit to the surrounding walls as indicated in the following figure.

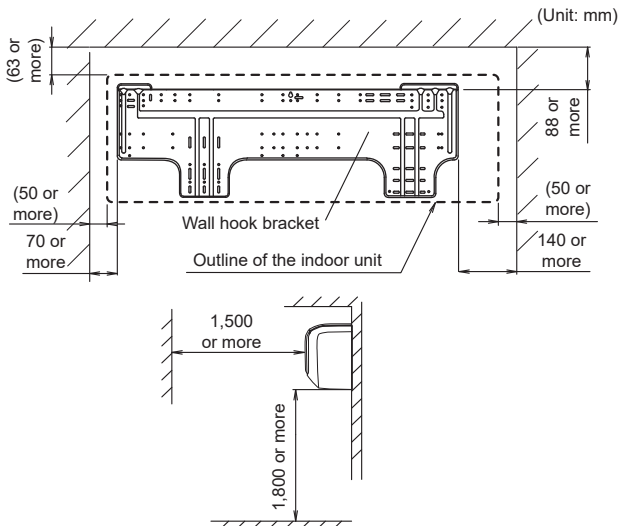

3.2. Removing and replacing parts

3.2.1. Intake grille removal and installation

■ Intake grille removal

- (1) Open the intake grille.
- (2) While pressing the left and right mounting shafts outward gently, pull the intake grille.

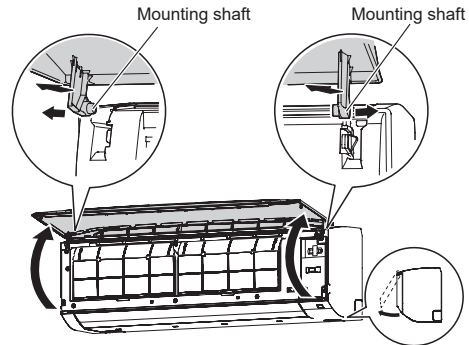

■ Intake grille installation

- (1) While holding the intake grille horizontal, set the left and right mounting shafts into the pillow blocks at the top of the front panel. Insert the shaft until it snaps to latch each shaft properly.

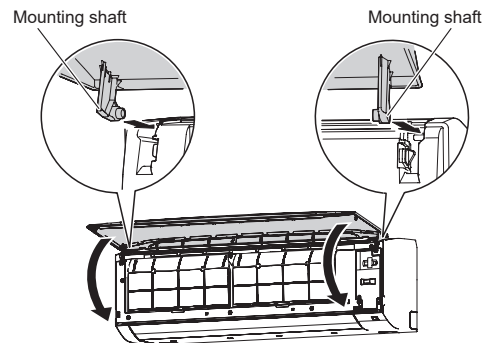

- (2) Close the intake grille.
- (3) Press 4 places on the intake grille to close it completely.

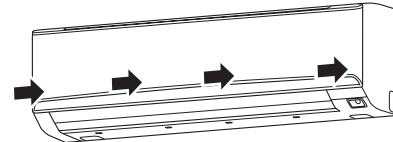

3.2.2. Front panel/control cover removal and installation

* In this description, the intake grille and wire cover already has been removed.

■ Front panel/control cover removal

- (1) Remove intake grille. (Refer to "Intake grille removal".)
- (2) Remove 4 caps.
- (3) Remove wire cover. (2-screws)
- (4) Remove 10 screws.

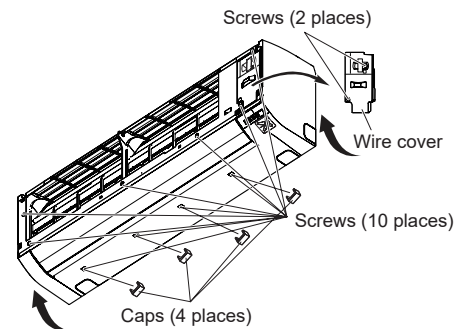

NOTES : When replacing the front panel, do not scratch or damage the louver.

- (5) The front panel is pulled to the front, raising the upper surface, then the front panel is removed.

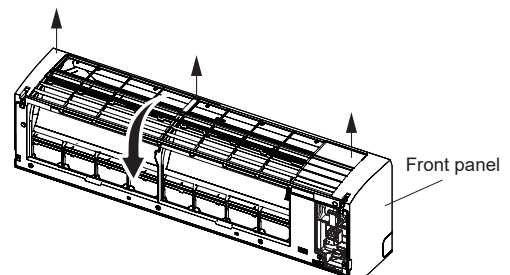

- (6) Remove 1 screw, then remove the control box cover.

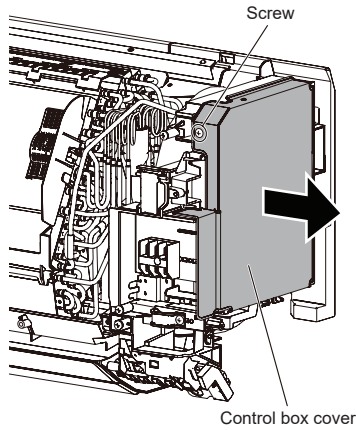

■ Front panel/control cover installation

- (1) Replace the control box cover and screw.

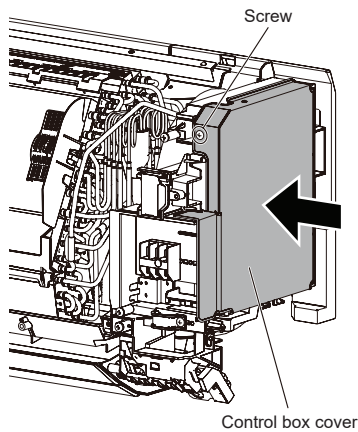

- (2) First, fit the lower part of the front panel, and insert top and middle hooks. (3 top sides, 5 middles)

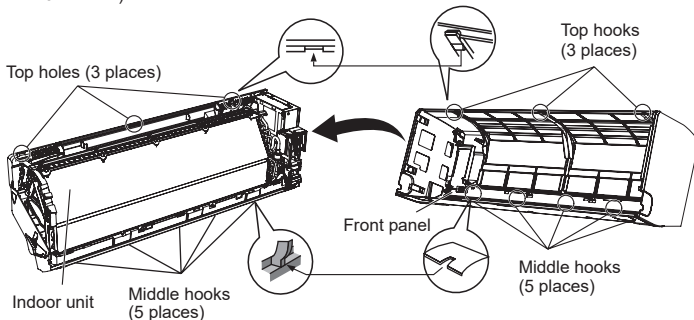

- (3) Attach the 10 screws.
 (4) Attach the wire cover. (2-screws)
 (5) Attach the 4 caps.
 (6) Attach the intake grille.

⚠ CAUTION

Please take caution when removing or installing the front panel. If the front panel falls, there is a risk of injury.

3.3. Pipe installation

3.3.1. Indoor unit piping direction

The piping can be connected in the 7 directions indicated in the following. When the piping is connected to direction (B), (C), (D) or (E), cut along the piping groove on the side and the under of the front cover with a hacksaw.

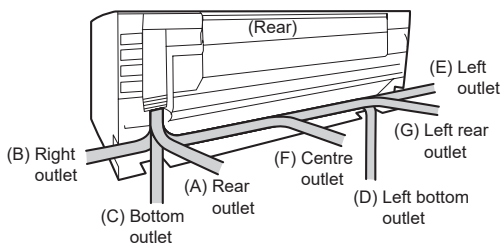

3.3.2. Cutting the hole in the wall for connecting the pipes

- (1) Cut a 80 mm diameter hole in the wall at the position shown in the following.
 (2) Cut the hole so that the outside end is lower (5 to 10 mm) than the inside end.

- (3) Always align the center of the wall hole. If misaligned, water leakage will occur.
 (4) Cut the wall pipe to match the wall thickness, stick it into the wall cap, fasten the cap with vinyl tape, and stick the pipe through the hole.
 (5) Cut the hole a little lower that drain water will flow freely.

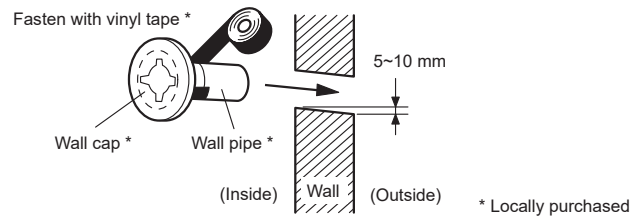
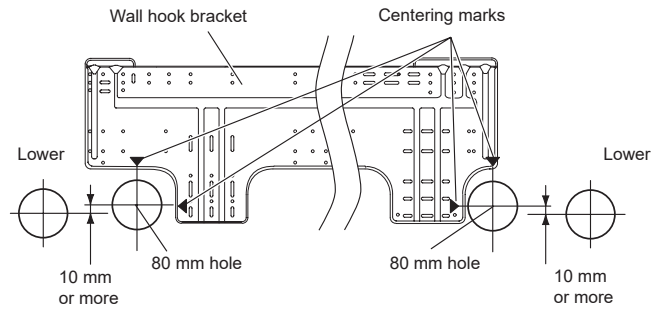

⚠ WARNING

Always use the wall pipe. If the wall pipe is not used, the cable that is connected between the indoor unit and the outdoor unit may touch metal, and cause an electric discharge.

3.3.3. Installing the wall hook bracket

- (1) Install the wall hook bracket so that it is correctly positioned horizontally and vertically. If the wall hook bracket is tilted, water will drip to the floor.
 (2) Install the wall hook bracket so that it is strong enough to support the weight of the unit.
 • Fasten the wall hook bracket to the wall with 5 or more screws through the holes near the outer edge of the bracket.
 • Check that there is no rattle at the wall hook bracket.

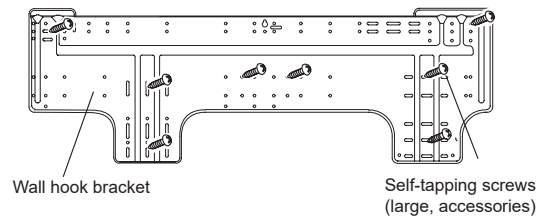

⚠ CAUTION

Install the wall-hook bracket both horizontally and vertically aligned. Misaligned installation may cause water leakage.

3.3.4. Forming the drain hose and pipe

⚠ CAUTION

- Insert drain hose and drain cap securely. Drain should slope down to avoid water leakage.
- When inserting the drain hose, no other material than water should be applied. Application of other material than water will cause deterioration of the hose, and may cause water leakage.
- After you remove a drain hose, be sure to attach the drain cap.
- When you secure the piping and drain hose with tape, arrange the drain hose so that it is at the bottom of the piping.
- For drain hose piping in low temperature environment, you need to apply freeze protection to prevent a frozen drain hose. After cooling operation is performed in low temperature environment (when outdoor temperature under 0 °C), water in the drain hose could be frozen. Frozen drain water will block the water flow in the hose, and may cause water leakage at the indoor unit.

■ Rear piping, Right piping, Bottom piping

- Install the indoor unit piping in the direction of the wall hole and bind the drain hose and pipe together with vinyl tape.
- Install the piping so that the drain hose is at the bottom.
- Wrap the pipes of the indoor unit that are visible from the outside with decorative tape.

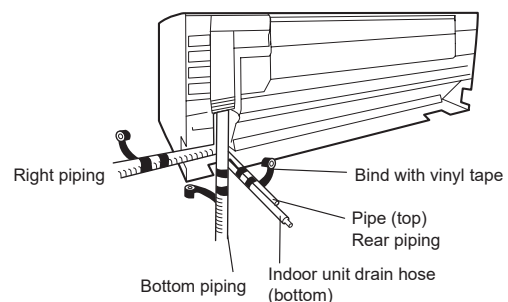

CAUTION

- When you secure the piping and drain hose with tape, arrange the drain hose so that it is at the bottom of the piping.
- Install the piping so that the drain hose is at the bottom.

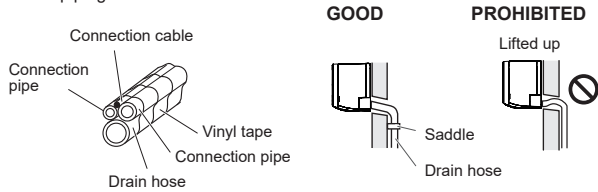

For Left rear piping (Drain hose), Left piping (Drain hose)

Interchange the drain cap and the drain hose.

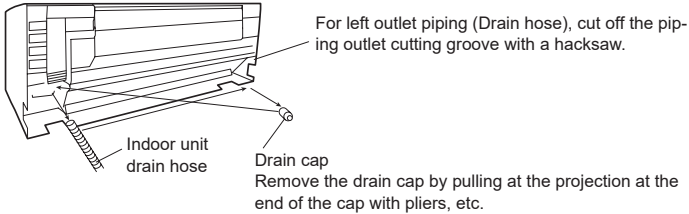

Installing the drain cap

Use a hexagonal wrench 4 mm at opposite side to insert the drain cap, till the drain cap contacts the tip of the drain cock.

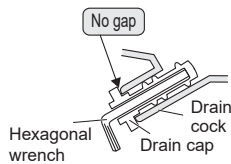

Removing the drain hose

Remove the screw at the left of drain hose and pull out drain hose.

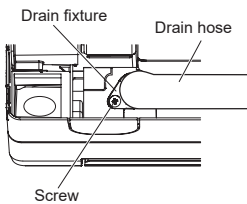

Installing the drain hose

Vertically insert the drain hose toward the inside, so that the drain fixture (white) can accurately align with the screw hole around the drain cock. After inserting and before replacing, reinstall and fix the removed screws.

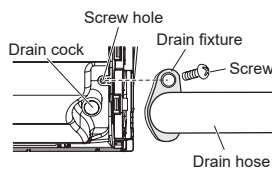

- Hold around the joint of the drain hose during work.
- As the screw is inside, be sure to use screwdrivers treated with magnet.

- After passing the indoor piping and drain hose through the wall hole, hang the indoor unit on the hooks at the top and bottom of the wall hook bracket.

CAUTION

Insert the drain hose and drain cap into the drain port, making sure that it comes in contact with the back of the drain port, and then mount it. If the drain hose is not connected properly, leaking will occur.

- For left piping and left rear piping, align the marks on the wall hook bracket and shape the connection pipe.
- Bend the connection piping at the bend radius of 100 mm or more and install no more than 35 mm from the wall.
- After passing the indoor piping and drain hose through the wall hole, hang the indoor unit on the hooks at the top and bottom of the wall hook bracket.

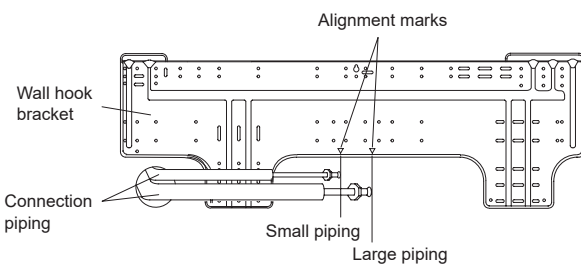

Installing the indoor unit

- Hang the indoor unit from the hooks at the top of the wall hook bracket.
- Insert the spacer, etc. between the indoor unit and the wall hook bracket and separate the bottom of the indoor unit from the wall.

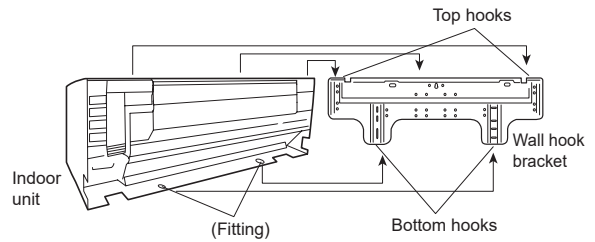
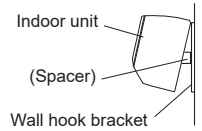

- After hooking the indoor unit to the top hook, hook the fittings of the indoor unit to the 2 bottom hooks while lowering the unit and pushing it against the wall.

3.3.5. Pipe connection

CAUTION

Tighten the flare nuts with a torque wrench using the specified tightening method. Otherwise, the flare nuts could break after a prolonged period, causing refrigerant to leak and generate hazardous gas if the refrigerant comes into contact with a flame.

Flaring

Use special pipe cutter and flare tool designed for R410A or R32 pipework.

- (1) Cut the connection pipe to the necessary length with a pipe cutter.
- (2) Hold the pipe downward so that cuttings will not enter the pipe and remove any burrs.
- (3) Insert the flare nut (always use the flare nut attached to the indoor unit(s) and outdoor unit or branch box respectively) onto the pipe and perform the flare processing with a flare tool. Use the special R410A or R32 flare tool, or the conventional flare tool. Leakage of refrigerant may result if other flare nuts are used.
- (4) Protect the pipes by pinching them or with tape to prevent dust, dirt, or water from entering the pipes.

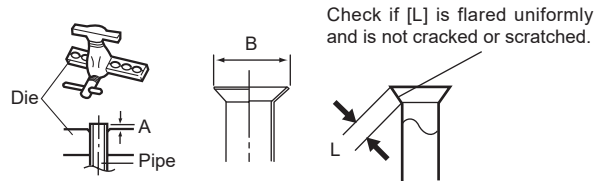

Pipe outside diameter [mm (in.)]	Dimension A [mm]	Dimension B [mm]
	Flare tool for R32, clutch type	
6.35 (1/4)	0 to 0.5	9.1
9.52 (3/8)		13.2
12.70 (1/2)		16.6
15.88 (5/8)		19.7
19.05 (3/4)		24.0

When using conventional flare tools to flare R32 pipes, the dimension A should be approximately 0.5 mm more than indicated in the table (for flaring with R32 flare tools) to achieve the specified flaring. Use a thickness gauge to measure the dimension A.

Pipe outside diameter [mm (in.)]	Width across flats of Flare nut [mm]
6.35 (1/4)	17
9.52 (3/8)	22
12.70 (1/2)	26
15.88 (5/8)	29
19.05 (3/4)	36

NOTES: The flare nut specification is compliant with ISO14903.

Bending pipes

CAUTION

- To prevent breaking of the pipe, avoid sharp bends.
- If the pipe is bent repeatedly at the same place, it will break.

- The pipes are shaped by your hands. Be careful not to collapse them.
- Bend R70 mm or more with a pipe bender.
- Do not bend the pipes in an angle more than 90°.
- When pipes are repeatedly bent or stretched, the material will harden, making it difficult to bend or stretch them anymore.
- Do not bend or stretch the pipes more than 3 times.

- When bending the pipe, do not bend it as is. The pipe will be collapsed. In this case, cut the insulating pipe with a sharp cutter as shown on the right, and bend it after exposing the pipe. After bending the pipe as you want, be sure to put the heat insulating pipe back on the pipe, and secure it with tape.

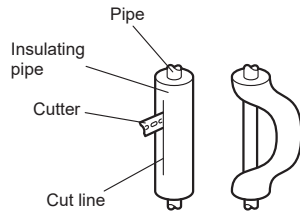

Flare connection

CAUTION

- Be sure to install the pipe against the port on the indoor unit correctly. If the centering is improper, the flare nut cannot be tightened smoothly. If the flare nut is forced to turn, the threads will be damaged.
- Do not remove the flare nut from the indoor unit pipe until immediately before connecting the connection pipe.
- Hold the torque wrench at its grip, keeping it in the right angle with the pipe, in order to tighten the flare nut correctly.
- Tighten the flare nuts with a torque wrench using the specified tightening method. Otherwise, the flare nuts could break after a prolonged period, causing refrigerant to leak and generate hazardous gas if the refrigerant comes into contact with a flame.
- Connect the piping so that the control box cover can easily be removed for servicing when necessary.
- In order to prevent water from leaking into the control box, make sure that the piping is well insulated.

When the flare nut is tightened properly by your hand, hold the body side coupling with a wrench, then tighten with a torque wrench. (Refer to the following table for the flare nut tightening torques.)

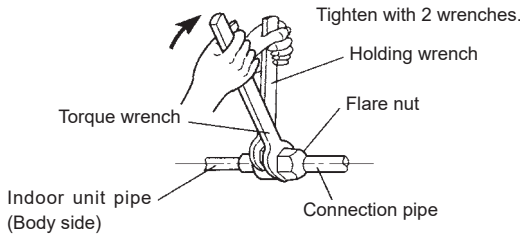

Flare nut [mm (in.)]	Tightening torque [N·m (kgf·cm)]
6.35 (1/4) dia.	16 to 18 (160 to 180)
9.52 (3/8) dia.	32 to 42 (320 to 420)
12.70 (1/2) dia.	49 to 61 (490 to 610)
15.88 (5/8) dia.	63 to 75 (630 to 750)
19.05 (3/4) dia.	90 to 110 (900 to 1,100)

Do not remove the cap from the connection pipe before connecting the pipe.

3.4. Electrical wiring

WARNING

- Before connecting the wires, make sure the power supply is OFF.
- Every wire must be connected firmly.
- No wire should be allowed to touch refrigerant tubing, the compressor, or any moving part.
- Loose wiring may cause the terminal to overheat or result in unit malfunction. A fire hazard may also exist. Therefore, be sure all wiring is tightly connected.
- Connect wires to the matching numbers of terminals.

CAUTION

- Be careful not to generate a spark as follows for using a flammable refrigerant.
- Do not remove the fuse while the power is on.
- Do not disconnect the wiring while the power is on.
- It is recommended to position the outlet connection in a high position. Place the cords so that they do not get tangled.

3.4.1. Wiring system diagram

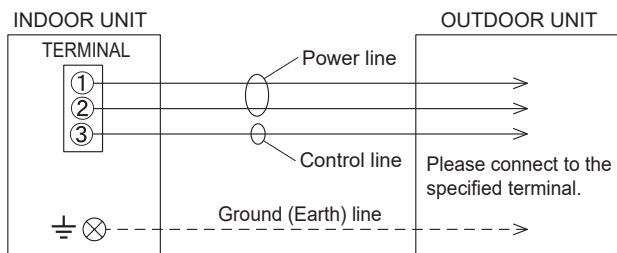

3.4.2. Indoor unit wiring

- Open the intake grille. Remove the self-tapping screw for the wire cover and remove the wire cover.

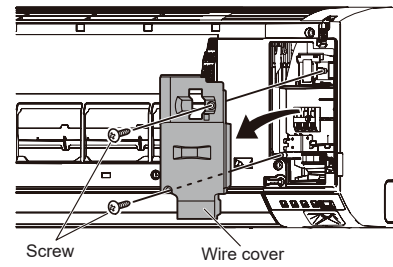

- Remove the self-tapping screw and while minding the cable clamp hook, remove the cable clamp.

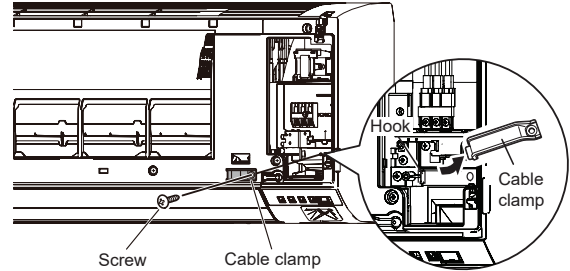

- Use the wire with ring terminals to connect to the terminal block.

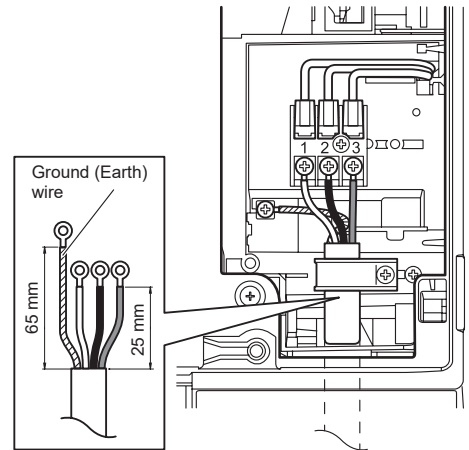

3.4.3. How to connect wiring to the terminals

Caution when wiring cable

To strip off the insulation of a lead wire, always use a special tool such as a wire stripper. If there is no special tool, carefully strip off the insulation by using a knife or other utensil.

- Use ring terminals with insulating sleeves as shown in the figure to connect to the terminal block.
- Securely clamp the ring terminals to the wires by using an appropriate tool so that the wires do not come loose.

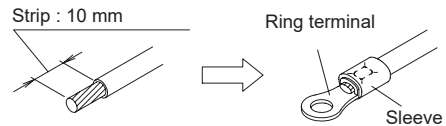

- Connect specified wires securely, and fasten them so that there is no stress applied on the terminals.
- Use a screwdriver with an appropriate bit size to tighten the terminal screws. Using of screwdriver with inappropriate bit size will damage the screw heads, and the screws will not be tightened properly.
- Do not overtighten the terminal screws. Otherwise, the screws may break.

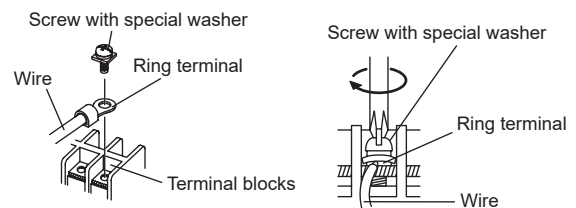

(6) Refer to the table for the terminal screw tightening torques.

Tightening torque [N·m (kgf·cm)]	
M4 screw	1.2 to 1.8 (12 to 18)

CAUTION

- Match the terminal block numbers and connection cable colors with those of the outdoor unit. Incorrect wiring may cause a fire.
- Connect the connection cables firmly to the terminal block. Imperfect installation may cause a fire.
- When fixing the connection cable with the cable clamp, always fasten the cable at the plastic jacket portion, but not at the insulator portion. If the insulator is chafed, electric leakage may occur.
- Always connect the ground (earth) wire. Improper earthing (grounding) work can cause electric shocks.
- Do not use the ground (earth) screw for the indoor unit to the outdoor unit unless it is specified.

3.5. Remote controller installation

Check that the indoor unit correctly receives the signal from the remote controller, then install the remote controller holder.

CAUTION

- Do not install the remote controller holder in the following conditions:
- Any places exposed in direct sunlight
 - Positions affected by the heat from a stove or heater

3.5.1. Remote controller holder installation

- Install the remote controller a maximum distance of 7 m from the remote control signal receiver. After installing the remote controller, check that it operates correctly.
- Install the remote controller holder to a wall, pillar, etc. with the self-tapping screw.

Remote controller holder fixing

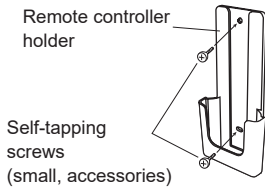

Remote controller mounting

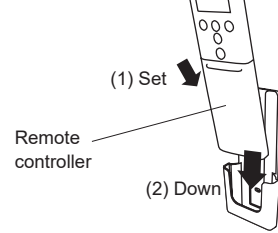

3.5.2. Remote controller custom setting

Use the following steps to select the custom code of the remote controller. (Note that the air conditioner cannot receive a signal if the air conditioner has not been set for the match-in custom code.)

- Press [START/STOP (⏻/⏷)] until only the clock is displayed on the remote controller display.
- Press [MODE] for at least 5 seconds to display the current custom code (initially set to A).
- Press [TEMP. (▲/▼)] to change the custom code between $\square \rightarrow A \leftrightarrow B \leftrightarrow C \leftrightarrow D \leftarrow \square$. Match the code on the display to the air conditioner custom code.
- Press [MODE] again to return to the clock display. The custom code will be changed.

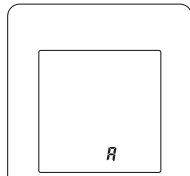

- To change the air conditioner custom code, contact an authorized service personnel (initially set to A).
- If you do not press any buttons for 30 seconds after the custom code is displayed, the display returns to the clock display. In this case, repeat the setting from step 2.
- Depending on the remote controller, the custom code may return to A when replacing the batteries. In this case, reset the custom code as necessary. If you do not know the air conditioner custom code, try each code until you find the code which operates the air conditioner.

4. OPTIONAL INSTALLATION WORK

CAUTION

- Before installing, be sure to disconnect all power supply.
 - Do not touch the heat exchanger.
 - When installing or removing parts of the air conditioner, be sure that the wire is not caught by any parts or pulled hard. It may result in damage or malfunction of the air conditioner.
- Connect the cable the circuit board.

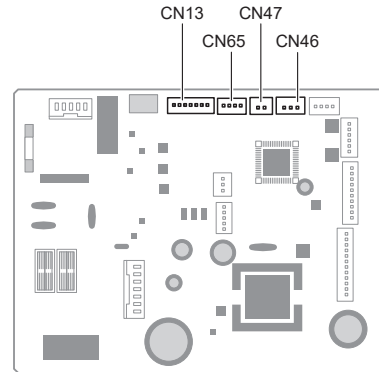

This air conditioner can be connected with the following optional kits. To install these optional kits, the optional External input and output PCB box is necessary. For details on how to install optional parts, refer to the installation manual included in each item.

Connector No.	Option type
CN13	Wired remote controller (via the Communication kit)
	Simple remote controller (via the Communication kit)
CN46	External input
CN47	External output
CN65	Other optional parts (External input and output PCB, Various converters, etc.) can be connectable. NOTE: The external input and output PCB and the converter cannot be used simultaneously.

4.1. Optional kit installation

NOTE: When some wired remote controller is connected, the wireless remote controller cannot be used.

4.1.1. Installing the WLAN adapter

- For installing the WLAN adapter, refer to the operation manual.

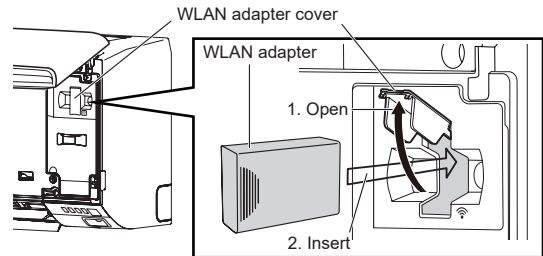

4.1.2. External input and output

External input

- Indoor unit functions such as Operation/Stop or Forced stop can be done by using indoor unit terminals.
- "Operation/Stop" mode or "Forced stop" mode can be selected with function setting of indoor unit.
- A twisted pair cable should be used. Maximum length of cable is 150 m.
- Use an external input and output cable with appropriate external dimension, depending on the number of cables to be installed.
- The wire connection should be separate from the power cable line.

Dry contact terminal

When a power supply is unnecessary at the input device you want to connect, use the Dry contact terminal.

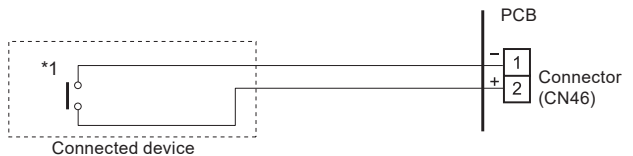

*1: The switch can be used on the following condition: DC 12 V to 24 V, 1 mA to 15 mA.

Operation behavior

Input signal type



When function setting is "Operation/Stop" mode 1.

Input signal	Command
OFF → ON	Operation
ON → OFF	Stop

When function setting is "Forced stop" mode.

Input signal	Command
OFF → ON	Forced stop
ON → OFF	Normal

* When the forced stop is triggered, indoor unit stops and Operation/Stop operation by a remote controller is restricted.

When function setting is "Operation/Stop" mode 2.

Input signal	Command
OFF → ON	Operation
ON → OFF	Stop (R.C. disabled)

NOTE: For details, refer to "External input control" in "5.1. Function details".

External output

- A twisted pair cable should be used. Maximum length of cable is 25 m.
- Use an external input and output cable with appropriate external dimension, depending on the number of cables to be installed.
- Output voltage: Hi DC12V±2V, Lo 0V.
- Permissible current: 50mA

Output select

When interlocking with external device

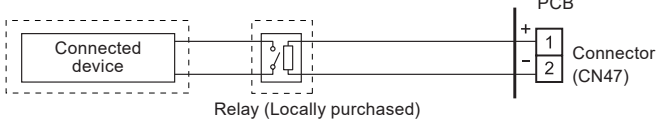

or

When displaying "Operation/Stop"

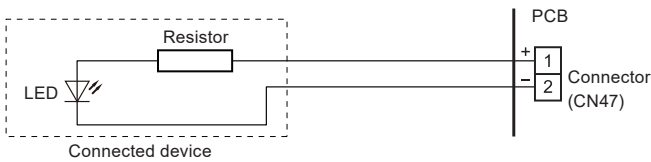

Operation behavior

*If function setting "60" is set to "00", refer to "5. FUNCTION SETTING".

Connection methods

Wire modification

- Remove insulation from wire attached to wire kit connector.
- Remove insulation from locally purchased cable. Use crimp type insulated butt connector to join field cable and wire kit wire.
- Connect the wire with connecting wire with solder.

IMPORTANT: Be sure to insulate the connection between the wires.

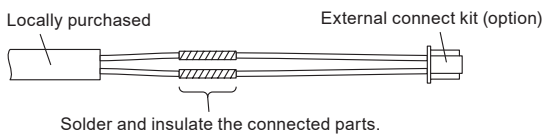

4.1.3. Installing the External input/output PCB

- (1) Remove the Intake grille, front panel, and control cover. Refer to "3.2. Removing and replacing parts".
- (2) Insert the PCB to the clasps (2 places). Push the PCB down until the clasp on the left is set.

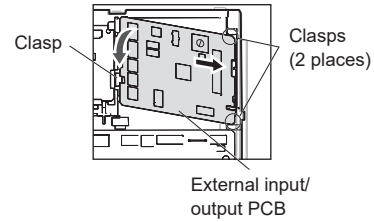

- (3) Hook the WLAN adapter wire to the control box. Fix it with a cable tie.

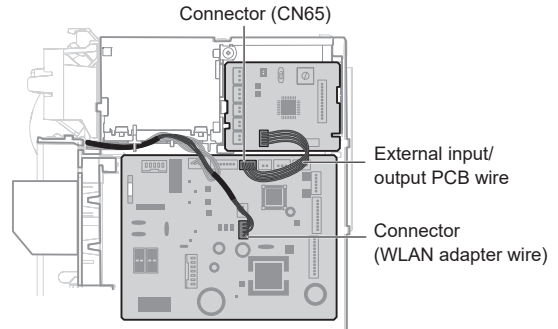

- (4) For the setting of rotary switch and DIP switch, refer to the installation manual of optional parts.

NOTE: If the rotary switch on the "External input and output PCB" is set to "1", function number "46" will operate.

- (5) Replace the control cover, front panel, and Intake grille.
- (6) Refer to "5.1. Function details External input control (Function number 46)" for setting.

4.1.4. Installing the communication kit

- (1) Remove the Intake grille, front panel, and control cover. Refer to "3.2. Removing and replacing parts".
- (2) Insert the PCB to the clasps (2 places). Push the PCB down until the clasp on the bottom is set.

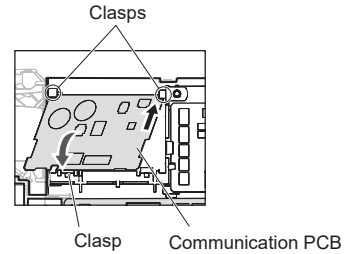

- (3) Attach the terminal board to the indoor unit with 1 screw (accessory for option).
- (4) Connect the connector of wire with EMI core to the communication PCB, then fix it with the cable tie (accessory for option).

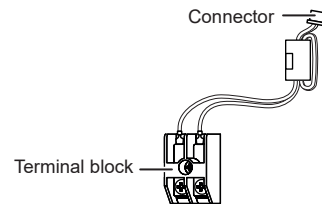

- (5) Connect the communication kit and main PCB.

- (6) Connect the wired remote controller cable to the terminal block as shown in the figure.

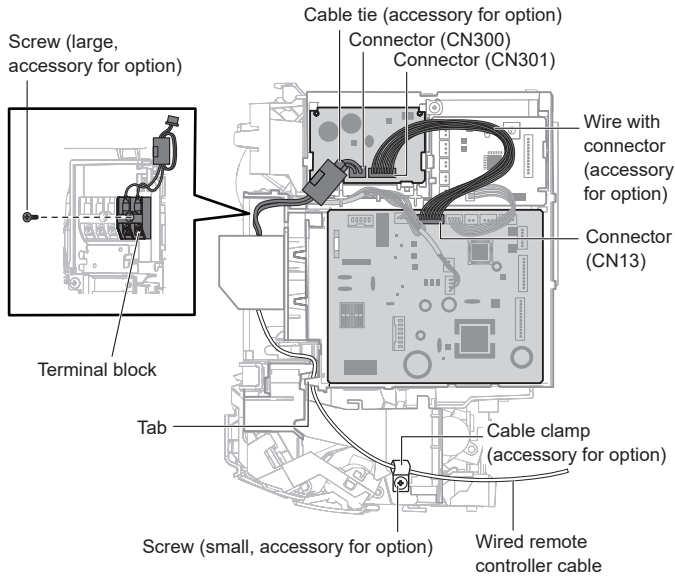

- (7) Replace the control cover, front panel, and Intake grille.

4.2. Group control

NOTES:

- Be sure to deactivate the Energy saving program (occupancy sensor) of the wireless remote controller when you use the group control. Otherwise you cannot operate the air conditioner by the wireless remote controller.
- You cannot use group control and wireless LAN control together.

4.2.1. Group control system

A number of indoor units can be operated at the same time using a single remote controller.
 *When different types of indoor units (such as wall-mounted type and cassette type, cassette type and duct type, or other combinations) are connected using group control system, some functions may no longer be available.

- (1) Connect up to 16 indoor units in a system.

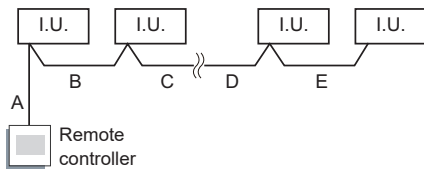

A, B, C, D, E: Remote controller cable.
 A+B+C+D+E ≤ 500 m.

Example of wiring method

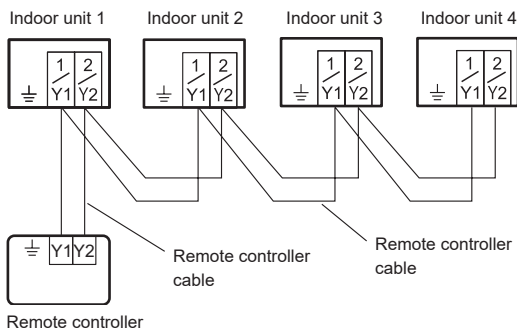

NOTE:

"1 / Y1": 1 or Y1, "2 / Y2": 2 or Y2

- (2) Address automatic setting

- Addresses will be automatically set when initially starting up this unit. In such a case, do not change the remote controller address for the indoor unit.

4.2.2. The Lead Lag function

- Lead Lag is a function of the wired remote controller.
- When enabling the Lead lag operation, the indoor units in the RC Group take turns stopping 1 or 2 at a time.

Indoor unit setting

- (1) Connect 2 or more indoor units and the wired remote controller (optional) in group.
- (2) Turn on the indoor unit.
- (3) Change the function setting according to the table below.
 For details, refer to "5. FUNCTION SETTING".

Function number	Setting value
42	01
48	01
96	01

- (4) Turn off the indoor unit, and then turn it on again.

Wired remote controller setting

- (1) Select "Enable" on the "Initial Setting > Lead Lag Setting > Enable/Disable" screen.
 * For details, refer to the operation manual and installation manual of the wired remote controller.

NOTES:

- When the Lead Lag is set to Enable, operation cannot be performed using the supplied wireless remote controller and the main unit switch.
- In the case of emergency, shut down the circuit breaker of the air conditioner to turn off the air conditioner.

5. FUNCTION SETTING

Perform the Function setting according to the installation conditions using the remote controller.

CAUTION

- Confirm whether the wiring work for outdoor unit has been finished.
- Confirm that the cover for the electrical enclosure on the outdoor unit is in place.

- This procedure changes to the Function settings used to control the indoor unit according to the installation conditions. Incorrect settings can cause the indoor unit to malfunction.
- After the power is turned on, perform the Function setting according to the installation conditions using the remote controller.
- The settings may be selected between the following two: Function number or setting value.
- Settings will not be changed if invalid numbers or setting values are selected.

Selecting the function number and setting value

- (1) While pressing [POWERFUL] and [TEMP. (Λ)] simultaneously, press [RESET] to enter the function setting mode.
- (2) Press [10°C HEAT].
- (3) Press [TEMP. (Λ / ∨)] to select the function number. (Press [10°C HEAT] to switch between the left and right digits.)
- (4) Press [POWERFUL] to proceed to setting value. (Press [POWERFUL] again to return to the function number selection.)
- (5) Press [TEMP. (Λ / ∨)] to select the setting value. (Press [10°C HEAT] to switch between the left and right digits.)
- (6) Press [MODE] once. Please confirm the beeping sound.
- (7) Next, please press [START/STOP (ϕ / |)] once to fix the Function setting. Please confirm the beeping sound.
- (8) Press [RESET] to cancel the function setting mode.
- (9) After completing the function setting, be sure to disconnect the power supply and then reconnect it.

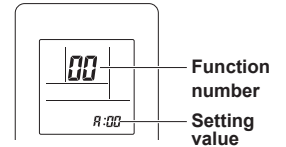

CAUTION

After disconnecting the power supply, wait 30 seconds or more before reconnecting it. The Function Setting will not become active unless the power supply is disconnected and then reconnected.

5.1. Function details

Filter sign

Select appropriate intervals for displaying the filter sign on the indoor unit according to the estimated amount of dust in the air of the room.

If the indication is not required, select "No indication" (03).

(♦... Factory setting)

Function number	Setting value	Setting description
11	00	Standard (400 hours)
	01	Long interval (1000 hours)
	02	Short interval (200 hours)
	03	No indication

■ Room temperature control for indoor unit sensor

Depending on the installed environment, correction of the room temperature sensor may be required.

Select the appropriate control setting according to the installed environment.

The temperature of the room temperature sensor is corrected as follows:

Corrected temp. = Temp. of room temp. sensor - correction temp. value

Example of correction :

When the temperature of room temp. sensor is 26°C and the setting value is "03" (-1.0°C), the corrected temp. will be 27°C (26°C - [-1.0°C]).

The temperature correction values show the difference from the "Standard setting" (00) (manufacturer's recommended value).

(◆... Factory setting)

Function number	Setting value	Setting description
30 (For cooling)	31 (For heating)	00 Standard setting ◆
		01 No correction 0.0 °C (0 °F)
		02 -0.5 °C (-1 °F)
		03 -1.0 °C (-2 °F)
		04 -1.5 °C (-3 °F)
		05 -2.0 °C (-4 °F)
		06 -2.5 °C (-5 °F)
		07 -3.0 °C (-6 °F)
		08 -3.5 °C (-7 °F)
		09 -4.0 °C (-8 °F)
		10 +0.5 °C (+1 °F)
		11 +1.0 °C (+2 °F)
		12 +1.5 °C (+3 °F)
		13 +2.0 °C (+4 °F)
		14 +2.5 °C (+5 °F)
		15 +3.0 °C (+6 °F)
		16 +3.5 °C (+7 °F)
17 +4.0 °C (+8 °F)		

■ Room temperature control for wired remote controller sensor

Depending on the installed environment, correction of the wire remote temperature sensor may be required.

Select the appropriate control setting according to the installed environment.

To change this setting, set Function 42 to "Both" (01).

Ensure that the Thermo Sensor icon is displayed on the remote controller screen.

(◆... Factory setting)

Function number	Setting value	Setting description
35 (For cooling)	36 (For heating)	00 No correction ◆
		01 No correction 0.0 °C (0 °F)
		02 -0.5 °C (-1 °F)
		03 -1.0 °C (-2 °F)
		04 -1.5 °C (-3 °F)
		05 -2.0 °C (-4 °F)
		06 -2.5 °C (-5 °F)
		07 -3.0 °C (-6 °F)
		08 -3.5 °C (-7 °F)
		09 -4.0 °C (-8 °F)
		10 +0.5 °C (+1 °F)
		11 +1.0 °C (+2 °F)
		12 +1.5 °C (+3 °F)
		13 +2.0 °C (+4 °F)
		14 +2.5 °C (+5 °F)
		15 +3.0 °C (+6 °F)
		16 +3.5 °C (+7 °F)
17 +4.0 °C (+8 °F)		

■ Auto restart

Enable or disable automatic restart after a power interruption.

(◆... Factory setting)

Function number	Setting value	Setting description
40	00	Enable ◆
	01	Disable

* Auto restart is an emergency function such as for power outage etc. Do not attempt to use this function in normal operation. Be sure to operate the unit by remote controller or external device.

■ Room temperature sensor switching

(Only for wireless remote controller)

When using the Wired remote controller temperature sensor, change the setting to "Both" (01). (◆... Factory setting)

Function number	Setting value	Setting description
42	00	Indoor unit ◆
	01	Both

00: Sensor on the indoor unit is active.

01: Sensors on both indoor unit and wired remote controller are active.

* Remote controller sensor must be turned on by using the remote controller

■ Remote controller custom code

(Only for wireless remote controller)

The indoor unit custom code can be changed. Select the appropriate custom code.

(◆... Factory setting)

Function number	Setting value	Setting description
44	00	A ◆
	01	B
	02	C
	03	D

■ External input control

"Operation/Stop" mode or "Forced stop" mode can be selected.

(◆... Factory setting)

Function number	Setting value	Setting description
46	00	Operation/Stop mode 1 (R.C. enabled) ◆
	01	(Setting prohibited)
	02	Forced stop mode
	03	Operation/Stop mode 2 (R.C. disabled)

■ Room temperature sensor switching (Aux.)

To use the temperature sensor on the wired remote controller only, change the setting to "Wired remote controller" (01). This function will only work if the function setting 42 is set at "Both" (01).

(◆... Factory setting)

Function number	Setting value	Setting description
48	00	Both ◆
	01	Wired remote controller

■ Indoor unit fan control for energy saving for cooling

Enables or disables the power-saving function by controlling the indoor unit fan rotation when the outdoor unit is stopped during cooling operation.

(◆... Factory setting)

Function number	Setting value	Setting description
49	00	Disable
	01	Enable
	02	Remote controller ◆

00: When the outdoor unit is stopped, the indoor unit fan operates continuously following the setting on the remote controller.

01: When the outdoor unit is stopped, the indoor unit fan operates intermittently at a very low speed.

02: Enable or disable this function by remote controller setting.

*When using a wired remote controller without Indoor unit fan control for energy saving for cooling function, or when connecting a single split converter, the setting cannot be made by using the remote controller. Set to (00) or (01).

To confirm if the remote controller has this function, refer to the operation manual of each remote controller.

■ Switching functions for external output terminal

Functions of the external output terminal can be switched.

(◆... Factory setting)

Function number	Setting value	Setting description
60	00	Operation status ◆
	01 to 08	(Setting prohibited)
	09	Error status
	10	Interlocked with indoor fans
	11	(Setting prohibited)

■ Special cooling operation

It is used to stabilize cooling when the ambient temperature is low.

Operation mode : Fixed cooling

Airflow : Fixed High

Set temperature : 24 °C (76 °F) to 30 °C (88 °F)

(◆... Factory setting)

Function number	Setting value	Setting description
96	00	Disable ◆
	01	Enable

NOTES:

- If setting value is set to "Enable"(01), connect the wired remote controller (optional).
- Do not use the wireless remote controller after setting to "Enable"(01).
- Cooling starts automatically after "Enable"(01) is set and the wired remote controller cannot be communicated with.
- If drops of water appear on the surface of the indoor unit after "Enable"(01) is set, set setting value to "Disable"(00).

Setting record

Record any changes to the settings in the following table.

Function number	Setting description	Setting value
11	Filter sign	
30	Room temperature control for indoor unit sensor	Cooling
31		Heating
35	Room temperature control for wired remote controller sensor	Cooling
36		Heating
40	Auto restart	
42	Room temperature sensor switching	
44	Remote controller custom code	
46	External input control	
48	Room temperature sensor switching (Aux.)	
49	Indoor unit fan control for energy saving for cooling	
60	Switching functions for external output terminal	
96	Special cooling operation	

After completing the Function Setting, be sure to disconnect the power supply and then reconnect it.

6. TEST RUN

Check items

- Is operation of each button on the remote controller normal?
- Does each lamp light normally?
- Do airflow direction louvers operate normally?
- Is the drain normal?
- Do not have an abnormal noise and vibration during operation?

Do not operate the air conditioner in test run for a long time.

Operation method

Before starting the test run, wait for 1 minute after connecting the power supply. Depending on your installation, choose from the following:

By the wireless remote controller (with [TEST RUN])

- (1) To start test run, press [START/STOP] and [TEST RUN] on the remote controller.
- (2) To end test run, press [START/STOP] on the remote controller.

By the indoor unit or IR receiver unit

- (1) To start test run, press [MANUAL AUTO] of the unit for more than 10 seconds (forced cooling).
- (2) To end test run, press [MANUAL AUTO] for more than 3 seconds or press [START/STOP] on the remote controller.
- (3) The Operation indicator lamp and Timer indicator lamp will simultaneously flash during the test run mode.

By the wired remote controller

- (1) For the operation method, refer to the installation manual and the operation manual of the wired remote controller.

Heating test run will begin in a few minutes when HEAT is selected by the remote controller [reverse cycle model only].

7. FINISHING

- (1) Insulate between pipes.
 - Insulate suction and discharge pipes separately.
 - For rear, right, and bottom piping, overlap the connection pipe heat insulation and indoor unit pipe heat insulation and bind them with vinyl tape so that there is no gap.
- (2) Temporarily fasten the connection cable along the connection pipe with vinyl tape. (Wrap to about 1/3 the width of the tape from the bottom of the pipe so that water does not enter.)
- (3) Fasten the connection pipe to the outside wall with a saddle, etc.
- (4) Fill the gap between the outside wall pipe hole and the pipe with sealer so that rain water and wind cannot blow in.
- (5) Fasten the drain hose to the outside wall, etc.
- (6) Check the drainage.

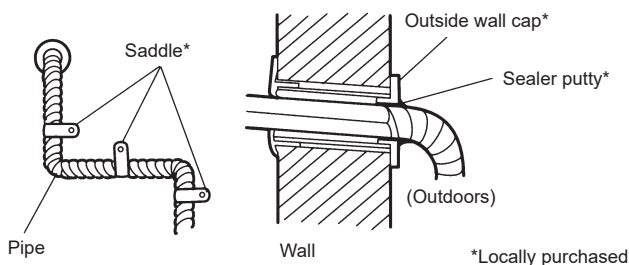

*Locally purchased

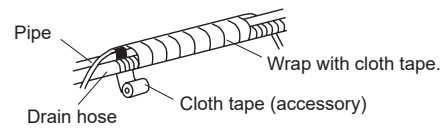
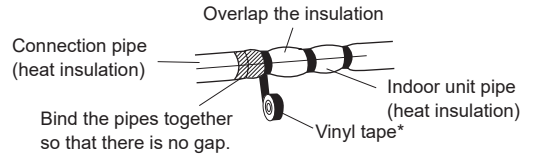

Drain hose insulation is used when the diameter of gas pipe is $\varnothing 12.70$ or more.



Butt connection pipe (heat insulation) against the indoor unit pipe (heat insulation) and wrap with drain hose insulation so that there is no gap.

GOOD

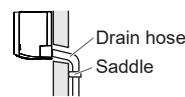

PROHIBITED

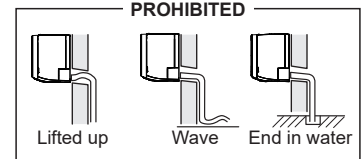

- (7) Open the intake grille of the indoor unit. Set an air cleaning filter (accessories) to each filter folder (accessories) and attach to the air filter. For details of how to assemble the air filter, please refer to the operation manual.

8. CUSTOMER GUIDANCE

- Explain the following to the customer in accordance with the operation manual:
- (1) Starting and stopping method, operation switching, temperature adjustment, timer, airflow switching, and other remote control unit operations.
 - (2) Air filter removal and cleaning, and how to use the air louvers.
 - (3) Give the operation manual to the customer.

9. ERROR CODES

If you use a wireless remote controller, the lamp on the photo detector unit will output error codes by way of blinking patterns. If you use a wired remote controller, error codes will appear on the remote control display. Refer to the lamp blinking patterns and error codes in the table. An error display is displayed only during operation.

The error code table contains errors irrelevant to this product as well.

Error display on the indoor unit

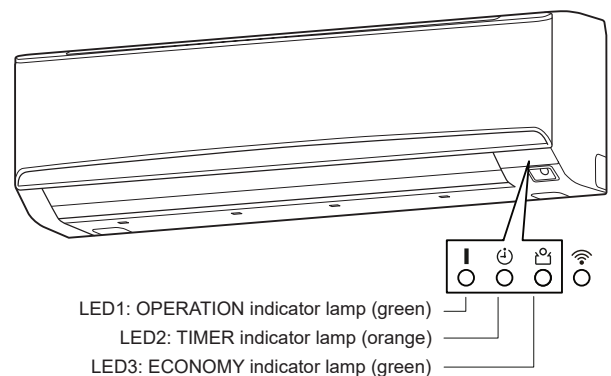

* : For wired remote controller (optional)

Error display			Error code*	Description
LED1 (green)	LED2 (orange)	LED3 (green)		
●(1)	●(1)	◇	11	Serial communication error
●(1)	●(2)	◇	12	Wired remote controller communication error
●(1)	●(5)	◇	15	Check run unfinished Automatic airflow adjustment error
●(1)	●(6)	◇	16	Peripheral unit transmission PCB connection error

Error display			Error code*	Description
LED1 (green)	LED2 (orange)	LED3 (green)		
●(1)	●(8)	◇	18	External communication error
●(2)	●(1)	◇	21	Unit number or Refrigerant circuit address setting error [Simultaneous Multi]
●(2)	●(2)	◇	22	Indoor unit capacity error
●(2)	●(3)	◇	23	Combination error
●(2)	●(4)	◇	24	• Connection unit number error (indoor secondary unit) [Simultaneous Multi] • Connection unit number error (indoor unit or branch unit) [Flexible Multi]
●(2)	●(6)	◇	26	Indoor unit address setting error
●(2)	●(7)	◇	27	Primary unit, secondary unit setup error [Simultaneous Multi]
●(2)	●(9)	◇	29	Connection unit number error in wired remote controller system
●(3)	●(1)	◇	31	Power supply interruption error
●(3)	●(2)	◇	32	Indoor unit PCB model information error
●(3)	●(3)	◇	33	Indoor unit motor electricity consumption detection error
●(3)	●(5)	◇	35	Manual auto switch error
●(3)	●(9)	◇	39	Indoor unit power supply error for fan motor
●(3)	●(10)	◇	3A	Indoor unit communication circuit (wired remote controller) error
●(4)	●(1)	◇	41	Room temp. sensor error
●(4)	●(2)	◇	42	Indoor unit heat ex. middle temp. sensor error
●(4)	●(4)	◇	44	Occupancy sensor error
●(5)	●(1)	◇	51	Indoor unit fan motor error
●(5)	●(3)	◇	53	Drain pump error
●(5)	●(4)	◇	54	Electric air cleaner reverse VDD error
●(5)	●(5)	◇	55	Filter set error
●(5)	●(7)	◇	57	Damper error
●(5)	●(8)	◇	58	Intake grille error
●(5)	●(9)	◇	59	Indoor unit fan motor 2 error (Left side fan)
●(5)	●(10)	◇	5A	Indoor unit fan motor 3 error (Right side fan)
●(5)	●(15)	◇	5U	Indoor unit error
●(6)	●(1)	◇	61	Outdoor unit reverse/missing phase and wiring error
●(6)	●(2)	◇	62	Outdoor unit main PCB model information error or communication error
●(6)	●(3)	◇	63	Inverter error
●(6)	●(4)	◇	64	Active filter error, PFC circuit error
●(6)	●(5)	◇	65	• Trip terminal L error • IPM temp error
●(6)	●(8)	◇	68	Outdoor unit rush current limiting resistor temp. rise error
●(6)	●(10)	◇	6A	Display PCB microcomputers communication error
●(7)	●(1)	◇	71	Discharge temp. sensor error
●(7)	●(2)	◇	72	Compressor temp. sensor error
●(7)	●(3)	◇	73	Outdoor unit Heat Ex. liquid temp. sensor error
●(7)	●(4)	◇	74	Outdoor temp. sensor error
●(7)	●(5)	◇	75	Suction Gas temp. sensor error

Error display			Error code*	Description
LED1 (green)	LED2 (orange)	LED3 (green)		
●(7)	●(6)	◇	76	• 2-way valve temp. sensor error • 3-way valve temp. sensor error
●(7)	●(7)	◇	77	Heat sink temp. sensor error
●(8)	●(2)	◇	82	• Sub-cool Heat Ex. gas inlet temp. sensor error • Sub-cool Heat Ex. gas outlet temp. sensor error
●(8)	●(3)	◇	83	Liquid pipe temp. sensor error
●(8)	●(4)	◇	84	Current sensor error
●(8)	●(6)	◇	86	• Discharge pressure sensor error • Suction pressure sensor error • High pressure switch error
●(9)	●(4)	◇	94	Trip detection
●(9)	●(5)	◇	95	Compressor rotor position detection error (permanent stop)
●(9)	●(7)	◇	97	Outdoor unit fan motor 1 error
●(9)	●(8)	◇	98	Outdoor unit fan motor 2 error
●(9)	●(9)	◇	99	4-way valve error
●(9)	●(10)	◇	9A	Coil (expansion valve) error
●(10)	●(1)	◇	A1	Discharge temp. error
●(10)	●(3)	◇	A3	Compressor temp. error
●(10)	●(4)	◇	A4	High pressure error
●(10)	●(5)	◇	A5	Low pressure error
●(10)	●(11)	◇	AC	Heat sink temp error
●(13)	●(2)	◇	J2	Branch boxes error [Flexible Multi]

Display mode ● : 0.5s ON / 0.5s OFF
◇ : 0.1s ON / 0.1s OFF
() : Number of flashing

■ Error code on the wired remote controller (option)

Check the error

1. If an error occurs, an error icon appears on the "Monitor mode screen". Touch the [Status] on the "Monitor mode screen". The "Status" screen is displayed.
2. Touch the [Error Information] on the "Status" screen. The "Error Information" screen is displayed. (If there are no errors, the [Error Information] will not be displayed.)
3. 2-digit numbers correspond to the error code in the table. Touch the [Next page] (or [Previous page]) to switch to other connected indoor units.

